

125-2-AUT-★

Deck Mounted Automatic Faucet

★ See next page for function options

Not temperature control – water must be premixed

Flow Rate: 1.2 GPM

Note: Sensor box may be installed a maximum of 12" linear from center of inlet.

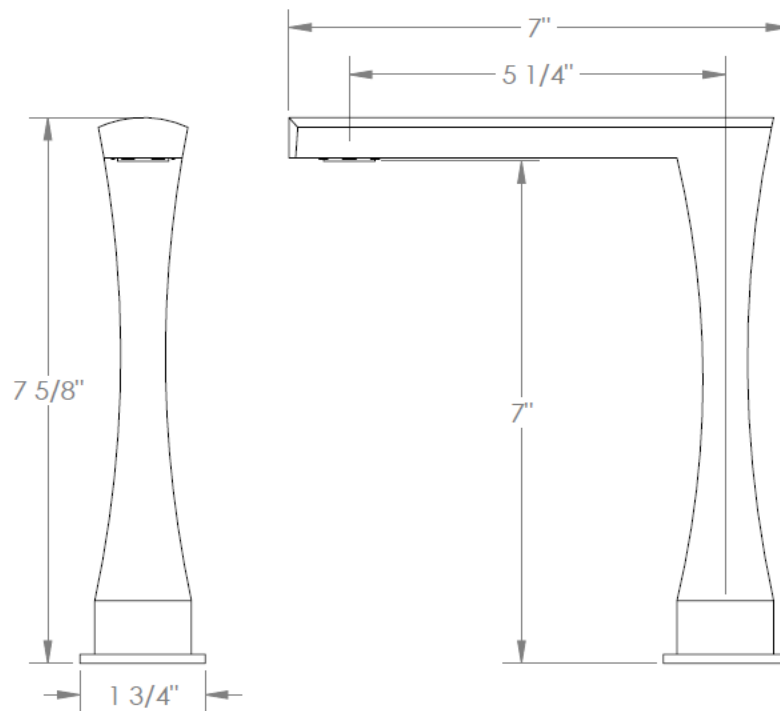

AUT-D-RGH

Automatic Faucet System

Includes CR-P2 6V Battery

DTM2 and DPM4: 12s metering cycle

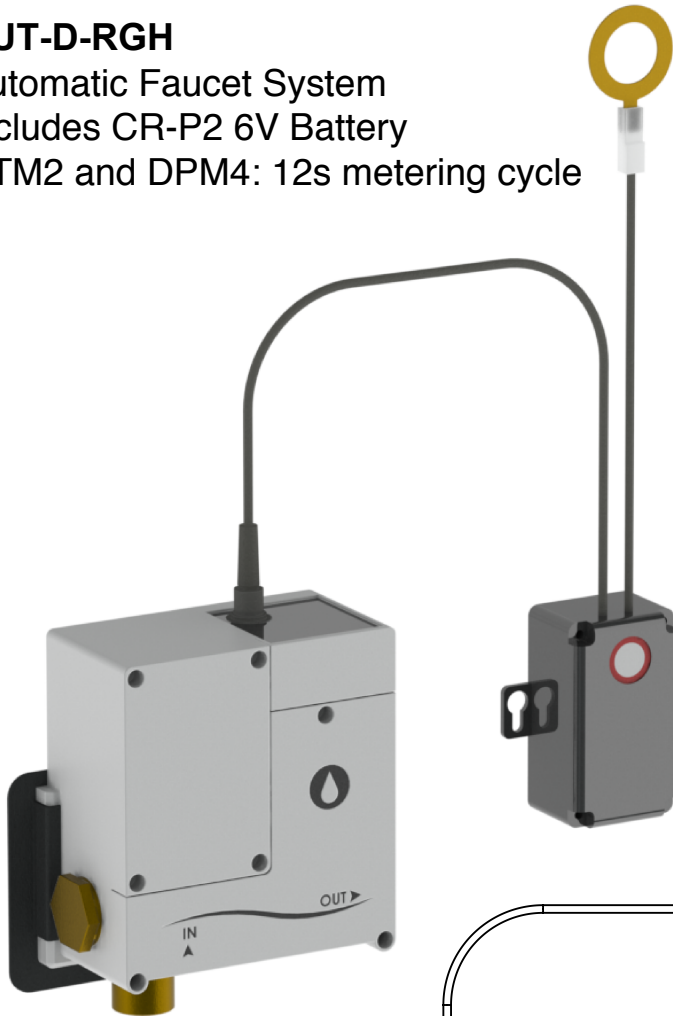

★ Function Options	
Code	Function
DT1	Touch on/off
DTM2	Metered touch
DP3	Touchfree
DPM4	Metered touchfree

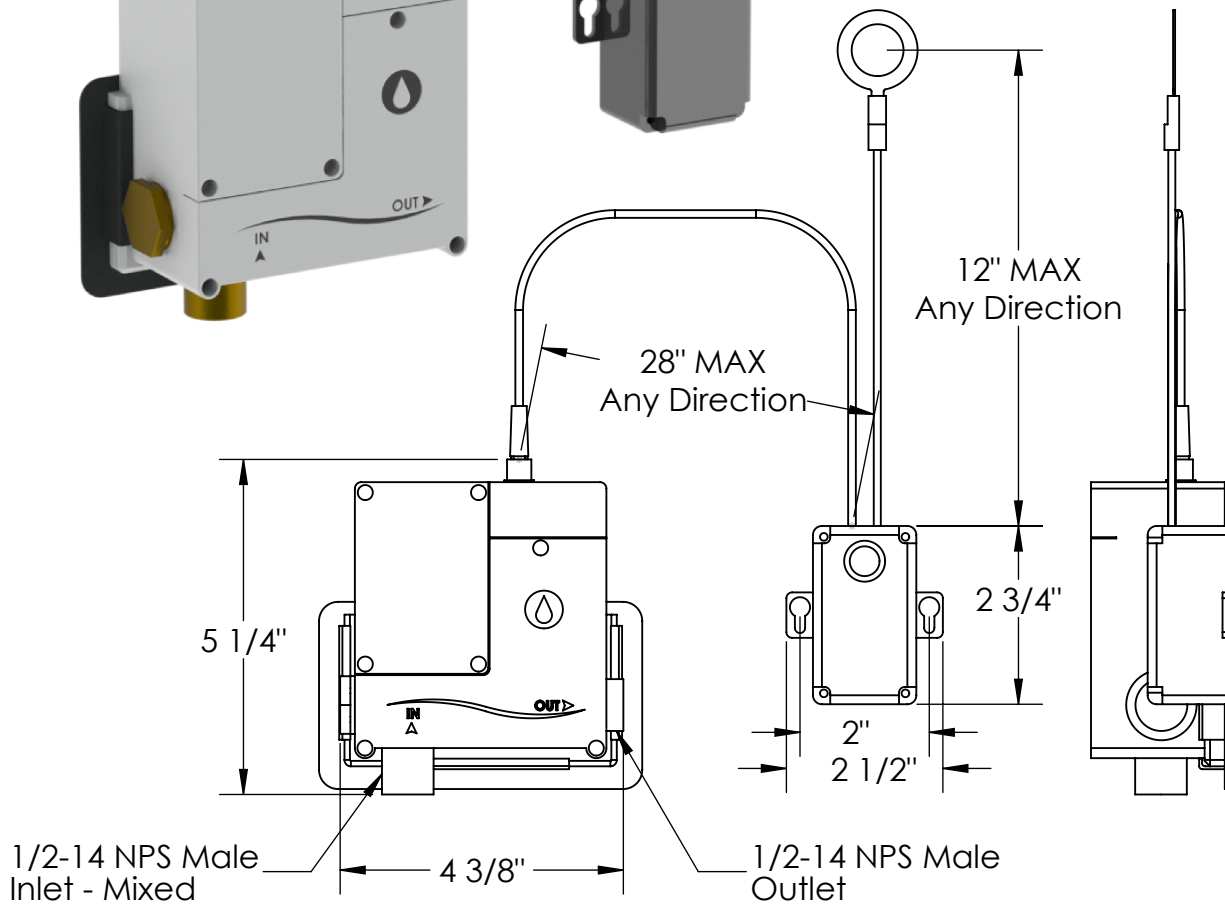

Meets the applicable requirements of ASME A112.18.1-2005/CSA B125.1-05, entitled "Plumbing Supply Fittings"